

Ersatzteile / spare parts

tus41123-20 Butterfly Octet 25/S-F1 (mit grüner 25-F1 Ob.)

tus41123-21 Butterfly Octet 25/S-F1 (mit blauer 25-F1 Ob.)

1 / 5

Nettopreis/net price

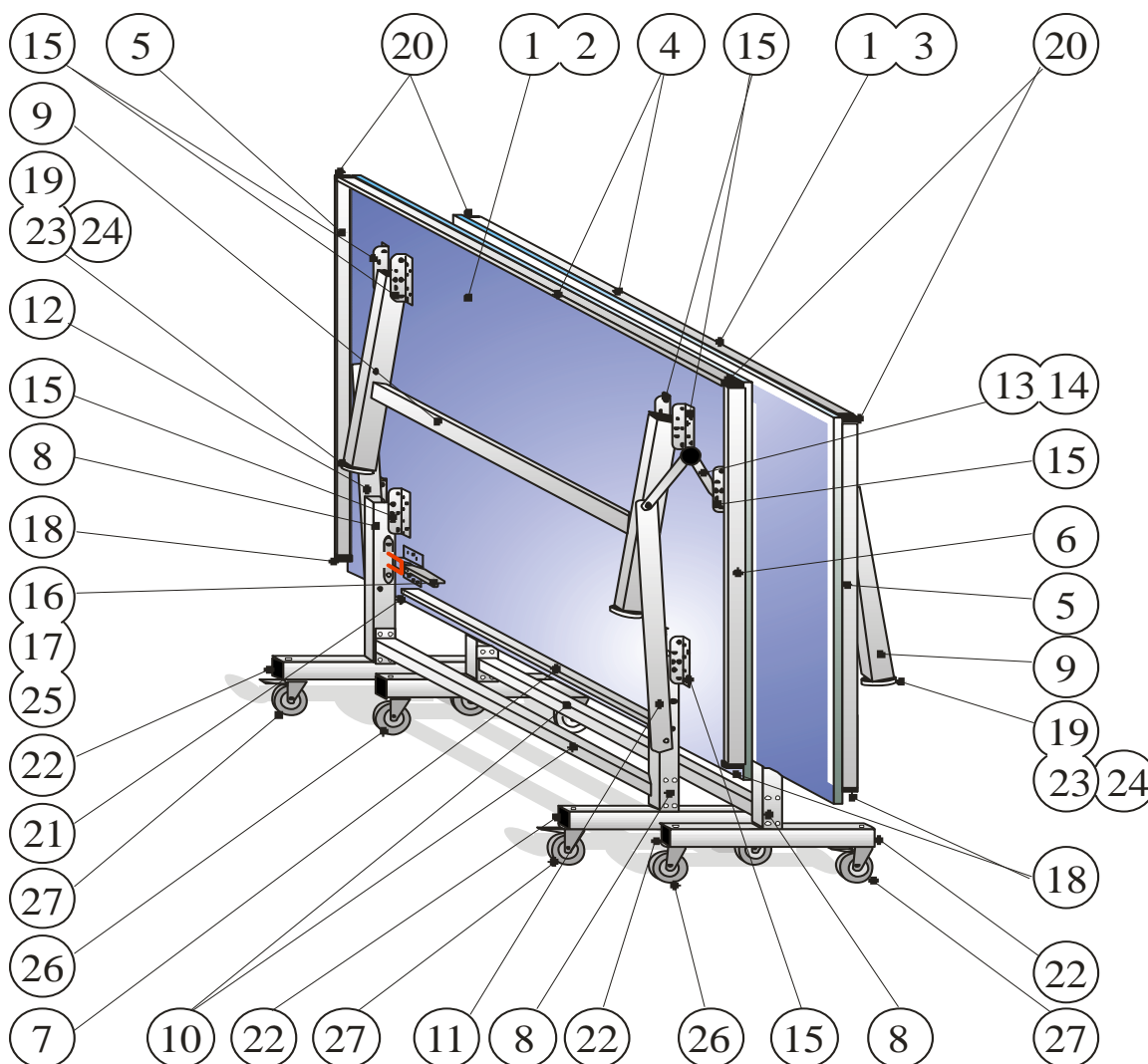

Gültig ab 01.09.2007
Valid from 01.09.2007

Bestellbeispiel für Ersatzteile / Ordering example for spare parts

St. pcs	Art-Nr. part No.	Bezeichnung name	Produkt product
------------	---------------------	---------------------	--------------------

Ersatzteile / spare parts

tus41123-20 Butterfly Octet 25/S-F1 (mit grüner 25-F1 Ob.)

2 / 5

tus41123-21 Butterfly Octet 25/S-F1 (mit blauer 25-F1 Ob.)

Nettopreis/net price

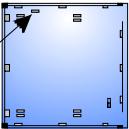
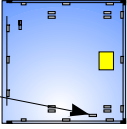
Nr. No.	Zeichnung diagramm	Bezeichnung name	St. pcs	Art-Nr. part No.
1		Oberfläche mit Linien 25 mm F1, grün <i>green top with lines 25 mm F1,</i>	2	bg02354-00
		Oberfläche mit Linien 25 mm F1, blau <i>blue top with lines 25 mm F1,</i>	2	bg02354-01
2		Plattenhälfte Butterfly Octet 25/F1 links grüne 25 mm F1-Oberfl. mit Zargen, Winkel und Schnäpper, inkl. Aufkleber: Bedienhinweis SC-Sperre Bedienhinweis Schnäpper m. Verriegelung <i>left green half top Butterfly Octet 25/F1 25 mm with frames, angles, and snaps incl. Stickers: operating hints lock operating hints snap</i>	1	bg03613-00
		Plattenhälfte Butterfly Octet 25/F1 links blaue 25 mm F1-Oberfl. mit Zargen, Winkel und Schnäpper, inkl. Aufkleber: Bedienhinweis SC-Sperre Bedienhinweis Schnäpper m. Verriegelung <i>left blue half top Butterfly Octet 25/F1 25 mm with frames, angles, and snaps incl. Stickers: operating hints lock operating hints snap</i>	1	bg03613-01
3		Plattenhälfte Butterfly Octet 25/F1 rechts grüne 25 mm F1-Oberfl. mit Zargen, Winkel und Schnäpper, inkl. Aufkleber: Bedienhinweis SC-Sperre Bedienhinweis Schnäpper m. Verriegelung Hinweis Pflege/Sicherheit <i>right green half top Butterfly Octet 25/F1 25 mm with frames, angles, and snaps incl. Stickers: operating hints lock operating hints snap, maintenance hints</i>	1	bg03614-00
		Plattenhälfte Butterfly Octet 25/F1 rechts blaue 25 mm F1-Oberfl. mit Zargen, Winkel und Schnäpper, inkl. Aufkleber: Bedienhinweis SC-Sperre Bedienhinweis Schnäpper m. Verriegelung Hinweis Pflege/Sicherheit <i>right blue half top Butterfly Octet 25/F1 25 mm with frames, angles, and snaps incl. Stickers: operating hints lock operating hints snap, maintenance hints</i>	1	bg03614-01







Ersatzteile / spare parts

tus41123-20 Butterfly Octet 25/S-F1 (mit grüner 25-F1 Ob.)

tus41123-21 Butterfly Octet 25/S-F1 (mit blauer 25-F1 Ob.)

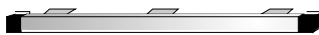
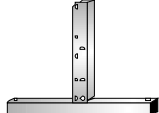
3 / 5

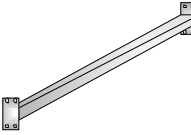
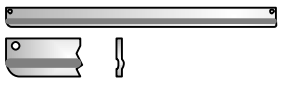
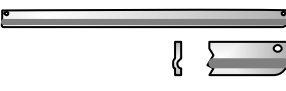
Nettopreis/net price

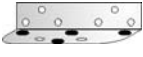
Nr. No.	Zeichnung diagramm	Bezeichnung name	St. pcs	Art-Nr. part No.
4		Zarge Butterfly lang schwarz <i>black long frame Butterfly</i>	2	bg00069-02
5		Zarge Butterfly Octet 25/S links montiert <i>left mounted frame Butterfly Octet 25/S</i>	2	bg03577-00
6		Zarge Butterfly Octet 25/S rechts montiert <i>right mounted frame Butterfly Octet 25/S</i>	2	bg03586-00
7		Verstärkung 900 mm schwarz mont. <i>black mounted support 900 mm</i>	2	bg00208-03
8		Fahrgestellbein rot montiert <i>red mounted chassis leg</i>	4	BG04206-01
9		H-Bein rot montiert (mit Höhenverstellgleiter) <i>red mounted folding leg (with height adjusters)</i>	2	BG01912-02
10		Querstrebe rot 1124 mm <i>red crossbeam 1124 mm</i>	2	BG01921-02
11	 links left	Beinaufsteller 50/654 li. rot <i>embossed left red leg strut 50/654</i>	2	BG03799-02
12	 rechts right	Beinaufsteller 50/654 rechts rot geprägt <i>embossed right red leg strut 50/654</i>	2	BG03800-02
13		Sicherungssperre/G2 rot rechts <i>right red safety lock G2</i>	2	bg03598-00
14		Schenkelfeder Ø2,5/143°/2 Wd. vz. (für Sicherungssperre) <i>zinc plated foot spring Ø2,5/143°/2 windings (for securing lock)</i>	2	k00707-00
15		Uniwinkel schwarz mit 4 Prägungen <i>black fastening angle with 4 stamps</i>	18	bg00009-01













Ersatzteile / spare parts

tus41123-20 Butterfly Octet 25/S-F1 (mit grüner 25-F1 Ob.)

tus41123-21 Butterfly Octet 25/S-F1 (mit blauer 25-F1 Ob.)

4 / 5

Nettopreis/net price

Nr. No.	Zeichnung diagramm	Bezeichnung name	St. pcs	Art-Nr. part No.
16		Schnäpper mit Verriegelung <i>snap with lock</i>	2	bg01790-00
17		Rastbügel Ø10/80/37 verzinkt <i>zinc-plated bow safety device Ø10/80/37</i>	2	z00992-00
18		Stopfen F 50x20 schwarz <i>black sealing F 50x20</i>	4	k00006-00
19		Stopfen F 50x20 m. Gewinde M10 schwarz <i>black sealing 50x20 with thread M10</i>	4	k00116-00
20		Eckverbinder 50x20x1 schwarz <i>black connection part 50x20x1</i>	4	k00007-00
21		Stopfen F 30x20 schwarz <i>black sealing F 30x20</i>	4	k00005-00
22		Stopfen E 30x30 schwarz <i>black sealing E 30x30</i>	8	k00085-00
23		Stellrad Ø29/42-M10x25 schwarz <i>black adjuster Ø29/42-M10x25</i>	4	k00117-00
24		Höhenverstellgleiter 50x20 M10 <i>mounted black adjuster 5x20 M10</i>	4	BG03868-00
25		Tauchkappe 11x5x30 rot	2	k00367-00
26		Lenkrolle Ø75 x 22 <i>swivel wheel Ø75 x 22</i>	4	k00078-00
27		Lenkrolle Ø75 x 22 mit Feststeller <i>swivel brake wheel Ø75 x 22</i>	4	k00079-00
		Schraubenpack HMTUS 1048-00 (ohne Rastbügel) <i>Assembly set HMTUS 1048-00</i> (without bow safety device)	1	bg01937-00

Ersatzteile / spare parts

tus41123-20 Butterfly Octet 25/S-F1 (mit grüner 25-F1 Ob.)

tus41123-21 Butterfly Octet 25/S-F1 (mit blauer 25-F1 Ob.)

5 / 5

Nettopreis/net price

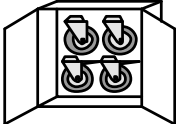
Nr. No.	Zeichnung diagramm	Bezeichnung name	St. pcs	Art-Nr. part No.
		Schraubenpack 10x55 (für Rollen) 4 St. M 10x55 DIN 931 vz 12 St. Ø10,5 DIN 125 vz. 4 St. Ø10,5 DIN 127 B 4 St. M10 DIN 555 vz. 2 St. Ringschlüssel SW17/M10 <i>srew set 10x55 (for wheels)</i> <i>4 pcs M 10x55 DIN 931 zi.</i> <i>12 pcs Ø 10,5 DIN 125 zi.</i> <i>4 pcs Ø 10,5 DIN 127 B</i> <i>4 pcs M10 DIN 555 zi.</i> <i>2 pcs wrenches SW17/M10</i>	2	bg00842-00
		Rollenpack Ø75x22 / 2+2 G <i>set wheels Ø75x22 / 2+2 G</i>	2	bg00564-00